



**CABLE INSTALLATION &
SUPPORT PRODUCTS
SAFE, DEPENDABLE
AND EASY TO USE**

CONTENTS

LIGHT-MEDIUM DUTY GRIPS

SE Type - Single Eye Cable Grip	4
OS Type – Offset Eye Cable Grip	4
DE Type - Double Eye Cable Grip	5
L Type - Lace Up Cable Grip	5
Fibre Optic Cable Grip	6

ACCESSORIES

Swivel Tester	6
Cable Laying Roller	6
Cable Lube	6

METRIC GRIPS

Flexible & Thimble Eye Cable Grip - Single Eye	7
Flexible & Thimble Eye Cable Grip - Double Eye	7

NON-METALLIC (ARAMID) GRIPS

NS – Non-Metallic (Aramid) Single Eye Cable Grip	8
ND – Non-Metallic (Aramid) Double Eye Cable Grip	8
NO - Non-Metallic (Aramid) Offset Eye Cable Grip	8

HEAVY DUTY LARGE DIAMETER GRIPS / HOSE ARMOUR

Marine Grips	9
Hose Armour Grips for Hose Protection	9

LINE PULLING SWIVELS

Line Pulling Swivel - Standard End	10
Line Pulling Swivel - Bull Nose	10

TECHNICAL INFORMATION

Important Technical and Safety Information	11
--	----

A GLOBAL BUSINESS
**BUILT ON QUALITY,
 INNOVATION AND SERVICE**

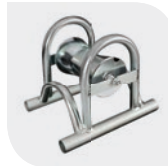

Welcome to Slingco, a world-leading supplier of cable grips and wire rope. Founded by our father, Chris Dykins, more than 40 years ago, Slingco remains a family-owned business but has evolved into an expert design and manufacturing operation, producing high quality cable grips, wire rope assemblies and more - products that are renowned for high performance in quality-critical applications.

Slingco operates out of regional bases in the UK and USA, but you'll find our products around the world, making heavy-duty cable and conductor installation and support a whole lot easier for people working in industries as varied as oil and gas, marine and offshore, public utilities, civil engineering, aerospace, transport, the military, performing arts, vehicle building, construction and more.

You can't make mistakes when you're dealing with products like ours. Too much depends on them. That's why we're obsessive about quality and innovation in design and manufacturing, and why nothing leaves our hands that isn't 100% dependable.

Because we understand exactly what your operation needs, we also know cost is a factor. We keep our prices realistic and hold a vast range of stock for fast – even same day – delivery.

We're brothers, partners and the driving force behind Slingco, but we're only a small part of the whole picture. We've got a fantastic team of skilled people who share our obsession with quality and great service. We're proud of every one of them.

Together, we're going to carry on developing outstanding products. We're going to carry on getting them out to you in record time. And we're going to carry on being the sort of company it's a pleasure to deal with.

NICK DYKINS
CEO, SLINGCO LIMITED

MATT DYKINS
PRESIDENT, SLINGCO AMERICA

**ALL SLINGCO PRODUCTS ARE
DESIGNED, MANUFACTURED AND
TESTED TO EXACTING STANDARDS**

**ENSURING SAFE AND DEPENDABLE
OPERATION UNDER EVEN THE MOST
CHALLENGING CONDITIONS**



QUALITY, SAFETY AND TESTING

Cables, conductors, hoses and their associated supports are by definition, safety-critical components and we recognize that this places us in a real position of responsibility. Hence all our products are designed, manufactured and tested to exacting standards to ensure safe and dependable operation under even the most challenging conditions. We operate a quality management system and are accredited to ISO 9001.

IN-HOUSE DESIGN

An integral part of our manufacturing facility is our dedicated in-house design engineering team. As well as being focused on our own design and development projects, our engineering team's skills - employing cutting-edge 3D modeling and finite element analysis software - are available to our customers.

From initial product design and manufacture to technical support and customer service, the strength of our business lies in the skills and commitment of our people. They're here to serve you and we're confident that this shows in everything we do.

If you've a specific requirement you think we could help with, or would just like to make contact for a general discussion, please call us on **+44 [0]1706 855558** or email **sales@slingco.com**.

LIGHT-MEDIUM DUTY GRIPS

SE TYPE - SINGLE EYE GRIP



Ideal for pulling light to medium loads; typical application - 'standard pull' of single or group of cables, where additional support is unnecessary, or if used in conjunction with other cable grips.

Slingco Part No	Range		Lattice Weave	Lattice Length		Overall Length		Approx. Break Load	
	in	mm		in	mm	in	mm	lb	kg
SINGLE EYE STANDARD GRIP - GALVANISED									
ZCS0320	0.25 - 0.50	10-13	Single	9	230	12	305	1,680	760
ZCS0321	0.50 - 0.75	13-19	Single	14	355	17	430	2,240	1,015
ZCS0322	0.75 - 1.00	19-25	Single	16	405	20	510	5,600	2,540
ZCS0323	1.00 - 1.50	25-38	Single	18	455	24	610	7,840	3,555
ZCS0324	1.50 - 2.00	38-50	Double	21	535	29	735	11,200	5,080
ZCS0325	2.00 - 2.50	50-63	Double	24	610	34	865	11,200	5,080
ZCS0326	2.50 - 3.50	63-89	Double	27	685	39	990	13,440	6,095
ZCS0327	3.50 - 4.50	89-115	Double	27	685	39	990	15,680	7,110
ZCS0821	4.50 - 5.50	115-140	Double	27	685	39	990	15,680	7,110
ZCS3574	5.31 - 6.30	135-160	Single	35.43	900	54.33	1,380	44,800	20,000
ZCS3575	6.33 - 7.48	161-190	Single	59.05	1,500	78.74	2,000	44,800	20,000
ZCS3576	7.51 - 8.66	191-220	Single	59.05	1,500	78.74	2,000	44,800	20,000
ZCS3577	8.70 - 9.84	221-250	Single	59.05	1,500	78.74	2,000	44,800	20,000
ZCS3578	9.88 - 11.81	251-300	Single	78.74	2,000	102.36	2,600	44,800	20,000
SINGLE EYE STANDARD GRIP - 316 STAINLESS STEEL									
ZCS1380	0.25 - 0.50	10-13	Single	9	230	12	305	1,344	610
ZCS1523	0.50 - 0.75	13-19	Single	14	355	17	430	1,792	810
ZCS1373	0.75 - 1.00	19-25	Single	16	405	20	510	4,480	2,030
ZCS1952	1.00 - 1.50	25-38	Single	18	455	24	610	6,272	2,845
ZCS1381	1.50 - 2.00	38-50	Double	21	535	29	735	8,960	4,065
ZCS1977	2.00 - 2.50	50-63	Double	24	610	34	865	8,960	4,065
ZCS1979	2.50 - 3.50	63-89	Double	27	685	39	990	10,752	4,875
ZCS1980	3.50 - 4.50	89-115	Double	27	685	39	990	12,544	5,690
ZCS1981	4.50 - 5.50	115-140	Double	27	685	39	990	12,544	5,690

DE TYPE - DOUBLE EYE GRIP



Ideal for pulling light to medium loads; the main advantage over the single eye cable grip is the cable being pulled can be passed through the grip, several cable grips can be used to support over a calculated distance.

Slingco Part No	Range		Lattice Weave	Lattice Length		Overall Length		Approx. Break Load	
	in	mm		in	mm	in	mm	lb	kg
DOUBLE EYE STANDARD GRIP - GALVANISED									
ZCS0305	0.25 - 0.50	10-13	Single	9	230	12	305	1,680	760
ZCS0306	0.50 - 0.75	13-19	Single	14	355	17	430	2,240	1,015
ZCS0307	0.75 - 1.00	19-25	Single	16	405	20	510	5,600	2,540
ZCS0308	1.00 - 1.50	25-38	Single	18	455	24	610	7,840	3,555
ZCS0309	1.50 - 2.00	38-50	Double	21	535	29	735	11,200	5,080
ZCS0310	2.00 - 2.50	50-63	Double	24	610	34	865	11,200	5,080
ZCS0311	2.50 - 3.50	63-89	Double	27	685	39	990	13,440	6,095
ZCS0312	3.50 - 4.50	89-115	Double	27	685	39	990	15,680	7,110
ZCS0878	4.50 - 5.50	115-140	Double	27	685	39	990	15,680	7,110
ZCS3579	5.31 - 6.30	135-160	Double	39.37	1,000	63	1,600	44,800	20,000
ZCS3580	6.33 - 7.48	161-190	Double	59.05	1,500	82.67	2,100	60,480	27,000
ZCS3581	7.51 - 8.66	191-220	Double	59.05	1,500	82.67	2,100	60,480	27,000
ZCS3582	8.70 - 9.84	221-250	Double	59.05	1,500	82.67	2,100	60,480	27,000
ZCS3583	9.88 - 11.81	251-300	Double	78.75	2,000	106.29	2,700	60,480	27,000
DOUBLE EYE STANDARD GRIP - 316 STAINLESS STEEL									
ZCS0823	0.25 - 0.50	10-13	Single	9	230	12	305	1,344	610
ZCS1007	0.50 - 0.75	13-19	Single	14	355	17	430	1,792	810
ZCS0931	0.75 - 1.00	19-25	Single	16	405	20	510	4,480	2,030
ZCS1265	1.00 - 1.50	25-38	Single	18	455	24	610	6,272	2,845
ZCS3995	1.14 - 1.57	29-40	Double	50	1,270	62	1,575	35,000	15,625
ZCS1252	1.50 - 2.00	38-50	Double	21	535	29	735	8,960	4,065
ZCS0319	2.00 - 2.50	50-63	Double	24	610	34	865	8,960	4,065
ZCS0213	2.50 - 3.50	63-89	Double	27	685	39	990	10,752	4,875
ZCS4873	2.50 - 3.50	63-89	Double	70	1,778	80	2,032	13,500	6,027
ZCS4596	2.50 - 3.50	63-89	Triple	56	1,422	152	3,860	16,138	7,204
ZCS0332	3.50 - 4.50	89-115	Double	27	685	39	990	12,544	5,690
ZCS1982	4.50 - 5.50	115-140	Double	27	685	39	990	12,544	5,690
ZCS4869	4.50 - 5.50	115-140	Double	70	1,778	80	2,032	13,500	6,027

OS TYPE – OFFSET EYE GRIP



Similar to the SE Type single eye cable grip, but for when offset positioning is required. Excellent for pulling slack out of lines that have been pulled. May also be used for removing underground cables when end of cable is available.

Slingco Part No	Range		Lattice Weave	Lattice Length		Overall Length		Approx. Break Load	
	in	mm		in	mm	in	mm	lb	kg
OFFSET EYE STANDARD GRIP - GALVANISED									
ZCS1860	0.25 - 0.50	6-13	Single	9	230	12	305	1,680	760
ZCS1861	0.50 - 0.75	13-19	Single	14	355	17	430	2,240	1,015
ZCS1862	0.75 - 1.00	19-25	Single	16	405	20	510	5,600	2,540
ZCS1863	1.00 - 1.50	25-38	Single	18	455	24	610	7,840	3,555
ZCS1864	1.50 - 2.00	38-50	Double	21	535	29	735	11,200	5,080
ZCS1865	2.00 - 2.50	50-63	Double	24	610	34	865	11,200	5,080
ZCS1866	2.50 - 3.50	63-89	Double	27	685	39	990	13,440	6,095
ZCS1867	3.50 - 4.50	89-115	Double	27	685	39	990	15,680	7,110
ZCS1974	4.50 - 5.50	115-140	Double	27	685	39	990	15,680	7,110
OFFSET EYE STANDARD GRIP - 316 STAINLESS STEEL									
ZCS1986	0.25 - 0.50	6-13	Single	9	230	12	305	1,344	610
ZCS1987	0.50 - 0.75	13-19	Single	14	355	17	430	1,792	810
ZCS1988	0.75 - 1.00	19-25	Single	16	405	20	510	4,480	2,030
ZCS1989	1.00 - 1.50	25-38	Single	18	455	24	610	6,272	2,845
ZCS1990	1.50 - 2.00	38-50	Double	21	535	29	735	8,960	4,065
ZCS1991	2.00 - 2.50	50-63	Double	24	610	34	865	8,960	4,065
ZCS1992	2.50 - 3.50	63-89	Double	27	685	39	990	10,752	4,875
ZCS1993	3.50 - 4.50	89-115	Double	27	685	39	990	12,544	5,690
ZCS1994	4.50 - 5.50	115-140	Double	27	685	39	990	12,544	5,690
ZCS3994	5.50 - 7.00	140-180	Double	24	610	39	990	4,500	2,009
ZCS4069	8.0 - 9.0	203-229	Double	59	1,500	74	1,880	20,000	8,928

L TYPE - LACE UP GRIP



Ideal for pulling light to medium loads; the L-type is fitted to the cable being pulled by stitching it together, like a football. Mainly used where a 'typical' cable grip can't be fitted over a connector at the end of a cable. For use in pulling when the end is not accessible. The L Type is wrapped around the cable, then closed with the wire lace provided.

Slingco Part No	Range		Lattice Weave	Lattice Length		Overall Length		Approx. Break Load	
	in	mm		in	mm	in	mm	lb	kg
LACE UP STANDARD GRIP - GALVANISED									
ZCS1157	0.25 - 0.50	10-13	Single	9	230	12	305	1,680	760
ZCS0872	0.50 - 0.75	13-19	Single	14	355	17	430	2,240	1,015
ZCS0871	0.75 - 1.00	19-25	Single	16	405	20	510	5,600	2,540
ZCS0328	1.00 - 1.50	25-38	Single	18	455	24	610	7,840	3,555
ZCS0329	1.50 - 2.00	38-50	Double	21	535	29	735	11,200	5,080
ZCS0330	2.00 - 2.50	50-63	Double	24	610	34	865	11,200	5,080
ZCS0331	2.50 - 3.50	63-89	Double	27	685	39	990	13,440	6,095
ZCS0853	3.50 - 4.50	89-115	Double	27	685	39	990	15,680	7,110
ZCS1109	4.50 - 5.50	115-140	Double	27	685	39	990	15,680	7,110
ZCS4463	4.72 - 5.90	120-150	Triple	59	1,500	102	2,600	32,928	14,700
ZCS3270	7.90 - 8.70	200-220	Triple	78	2,000	102	2,600	71,680	32,000
ZCS3584	5.31 - 6.30	135-160	Double	39.37	1,000	63	1,600	38,080	17,000
ZCS3585	6.33 - 7.48	161-190	Double	59.05	1,500	82.67	2,100	38,080	17,000
ZCS3586	7.51 - 8.66	191-220	Double	59.05	1,500	82.67	2,100	38,080	17,000
ZCS3587	8.70 - 9.84	221-250	Double	59.05	1,500	82.67	2,100	38,080	17,000
ZCS3588	9.88 - 11.81	251-300	Double	78.74	2,000	106.29	2,700	38,080	17,000
LACE UP STANDARD GRIP - 316 STAINLESS STEEL									
ZCS1983	0.25 - 0.50	10-13	Single	9	230	12	305	1,344	610
ZCS1796	0.50 - 0.75	13-19	Single	14	355	17	430	1,792	810
ZCS1789	0.75 - 1.00	19-25	Single	16	405	20	510	4,480	2,030
ZCS1797	1.00 - 1.50	25-38	Single	18	455	24	610	6,272	2,845
ZCS1984	1.50 - 2.00	38-50	Double	21	535	29	735	8,960	4,065
ZCS2466	2.00 - 2.50	50-63	Double	24	610	34	865	8,960	4,065
ZCS0816	2.50 - 3.50	63-89	Double	27	685	39	990	10,752	4,875
ZCS5094	2.75 - 3.44	69-87	Multiple	55	1,390	81	2,063	40,000	17,857
ZCS1356	3.50 - 4.50	89-115	Double	27	685	39	990	12,544	5,690
ZCS2832	3.50 - 4.50	89-115	Triple	27	685	39	990	14,012	6,300
ZCS1355	4.50 - 5.50	115-140	Double	27	685	39	990	12,544	5,690
ZCS2833	4.50 - 5.50	115-140	Triple	27	685	39	990	16,128	7,315

LIGHT-MEDIUM DUTY GRIPS / ACCESSORIES

FIBRE OPTIC CABLE GRIP



Dual weave design from galvanised wire rope. Used for the installation of fibre optic cables for either overhead or underground applications. Made of galvanised steel.

Slingco Part No	Range		Lattice Length		Overall Length		Approx. Break Load	
	in	mm	in	mm	in	mm	lb	kg
ZCS2008	0.11 - 0.23	2.5 - 5.6	11	265	18	455	950	455
ZCS2009	0.21 - 0.36	5.3 - 9.2	15	370	22	560	1,650	560
ZCS2010	0.32 - 0.49	8.1 - 12.5	19	470	27	690	2,200	690
ZCS2011	0.42 - 0.62	10.7 - 15.8	20	515	29	735	2,750	735
ZCS2012	0.53 - 0.75	13.5 - 19.1	23	595	32	815	3,700	815
ZCS2013	0.64 - 0.88	16.3 - 22.4	25	645	34	865	4,250	865
ZCS2014	0.75 - 1.00	19.1 - 25.5	27	720	37	940	4,250	940

CABLE LAYING ROLLERS



They are of steel construction with zinc plating for general purpose cable installation work in trenches. They are suitable for power, telecoms and utility installations, and can bridge existing cables in trenches or ducts.

Slingco part no.	Base footprint in (mm)	Height to top of roller in (mm)	Handle height in (mm)
ZGP2395	12 x 9 1/2 (305 x 240)	7 1/8 (180)	10 (255)

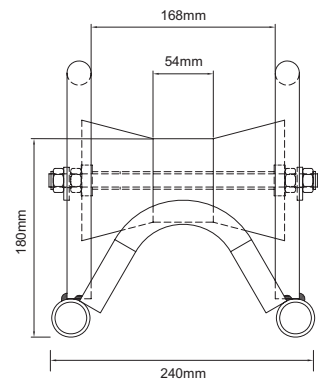

Other cable laying roller configurations are also available, as shown below. Please contact us for more details.

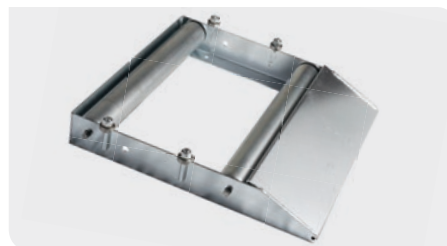

CAN'T FIND THE SPECIFICATION YOU NEED?

Call or email for full ranges plus custom manufacture options

01706 855558

sales@slingco.com

Designed to fit the typical European range of cables, and with a longer lattice length, these grips are ideal for pulling medium to heavy loads. Made of galvanised steel.

FLEXIBLE & THIMBLE EYE GRIP - SINGLE EYE



This grip has a flexible eye construction – and is also available with a reinforced thimble eye.

Flexible Eye	Thimble Eye		Range		Lattice Length		Overall Length		Approx. Break Load	
			mm	in	mm	in	mm	in	kg	lb
ZCS0824	ZCS3133	Single	15-20	0.59-0.79	1,220	48	1,358	53.5	1,240	2,730
ZCS0825	ZCS3134	Single	20-30	0.79-1.18	1,250	49	1,358	53.5	1,530	3,370
ZCS0826	ZCS3135	Double	20-30	0.79-1.18	1,250	49	1,393	55	1,990	4,380
ZCS0827	ZCS3136	Single	30-40	1.18-1.57	1,250	49	1,393	55	2,550	5,620
ZCS0828	ZCS3137	Double	30-40	1.18-1.57	1,250	49	1,652	65	3,060	6,740
ZCS0829	ZCS3138	Double	40-50	1.57-1.97	1,500	59	1,661	65.5	5,930	13,060
ZCS0830	ZCS3139	Double	50-60	1.97-2.36	1,500	59	1,750	69	6,630	14,610
ZCS0831	ZCS3140	Double	60-70	2.36-2.76	1,500	59	1,750	69	7,790	17,160
ZCS0832	ZCS3141	Double	70-90	2.76-3.54	1,500	59	1,750	69	8,110	17,870
ZCS0833	ZCS3142	Double	90-110	3.54-4.33	1,500	59	1,750	69	11,830	26,070
ZCS0834	ZCS3143	Double	110-130	4.33-5.12	1,500	59	1,750	69	11,830	26,070
ZCS0835	ZCS3144	Double	120-150	4.72-5.91	1,500	59	1,750	69	12,750	28,100
ZCS0836	ZCS3145	Double	140-180	5.51-7.09	1,500	59	1,750	69	12,750	28,100



Slingco Part No	Range	Lattice Length		Approx. Break Load		
		in	mm	in	mm	lb
SHORTER LENGTH						
ZCS4783	2.36 - 2.75	60 - 70	43	1,096	17,450	7,790
ZCS4784	2.75 - 3.54	70 - 90	43	1,096	18,166	8,110
ZCS4785	3.54 - 4.33	90 - 110	43	1,096	26,500	11,830
ZCS4786	4.33 - 5.11	110 - 130	43	1,096	26,500	11,830
ZCS4787	4.72 - 5.90	120 - 150	43	1,096	28,560	12,750

FLEXIBLE & THIMBLE EYE GRIP - DOUBLE EYE



This grip has a double eye construction allowing the cables being pulled to pass through the grip. Available with flexible eye or reinforced thimble eye.

Flexible Eye	Thimble Eye		Range		Lattice Length		Overall Length		Approx. Break Load	
			mm	in	mm	in	mm	in	kg	lb
ZCS0837	ZCS3146	Single	15-20	0.59-0.79	1,250	49	1,500	59	1,240	2,730
ZCS0838	ZCS3147	Single	20-30	0.79-1.18	1,250	49	1,500	59	1,530	3,370
ZCS0839	ZCS3148	Double	20-30	0.79-1.18	1,250	49	1,500	59	1,990	4,380
ZCS0840	ZCS3149	Single	30-40	1.18-1.57	1,250	49	1,500	59	2,550	5,620
ZCS0841	ZCS3150	Double	30-40	1.18-1.57	1,250	49	1,500	59	3,060	6,740
ZCS0842	ZCS3151	Double	40-50	1.57-1.97	1,500	59	1,750	69	5,930	13,060
ZCS0843	ZCS3152	Double	50-60	1.97-2.36	1,500	59	1,750	69	6,630	14,610
ZCS0844	ZCS3153	Double	60-70	2.36-2.76	1,500	59	1,750	69	7,790	17,160
ZCS0846	ZCS3154	Double	70-90	2.76-3.54	1,500	59	1,750	69	8,110	17,870
ZCS0847	ZCS3155	Double	90-110	3.54-4.33	1,500	59	1,750	69	11,830	26,070
ZCS0848	ZCS3156	Double	110-130	4.33-5.12	1,500	59	1,750	69	11,830	26,070
ZCS0849	ZCS3157	Double	120-150	4.72-5.91	1,500	59	1,750	69	12,750	28,100
ZCS0850	ZCS3158	Double	140-180	5.51-7.09	1,500	59	1,750	69	12,750	28,100

NON-METALLIC (ARAMID) GRIPS

Ideal for fibre optic applications, offshore or for a multitude of uses in the electrical industry; dramatically improved weight to break ratio. Slingco's non-metallic pulling grips are made of a high-strength, non-metallic aramid fibre, with UV protective coating; they are suitable for pulling both single cable and cable bundles. These woven mesh grips offer a non-metallic alternative to steel. Non-metallic material is easy to work with even without gloves.

NS – NON-METALLIC (ARAMID) SINGLE EYE GRIP



Slingco Part No	Range		Lattice Length		Approx. Break Load	
	in	mm	in	mm	lb	kg
SINGLE EYE SINGLE WEAVE NON-METALLIC GRIP						
ZCS1040	0.38 - 0.75	10 - 20	24	600	2,460	1,115
ZCS1022	0.75 - 1.25	20 - 30	24	600	3,580	1,620
ZCS2923	1.00 - 1.50	25 - 36	24	600	3,580	1,620
ZCS1041	1.25 - 1.50	30 - 40	24	600	4,920	2,230
ZCS1042	1.50 - 2.00	40 - 50	24	600	5,820	2,640
SINGLE EYE DOUBLE WEAVE NON-METALLIC GRIP						
ZCS1023	1.25 - 1.50	30 - 40	24	600	9,860	4,470
ZCS1024	1.50 - 2.00	40 - 50	24	600	11,880	5,390
ZCS1179	2.00 - 2.50	50 - 65	24	600	15,900	7,210
ZCS1180	2.50 - 3.00	65 - 80	24	600	15,900	7,210
ZCS1181	3.00 - 4.00	80 - 100	37	940	15,900	7,210
ZCS4079	4.00 - 5.00	102 - 127	120	3,048	15,900	7,210

ND – NON-METALLIC (ARAMID) DOUBLE EYE GRIP



Slingco Part No	Range		Lattice Length		Approx. Break Load	
	in	mm	in	mm	lb	kg
DOUBLE EYE SINGLE WEAVE NON-METALLIC GRIP						
ZCS1148	0.38 - 0.75	10 - 20	24	600	2,460	1,115
ZCS1176	0.75 - 1.25	20 - 30	24	600	3,580	1,620
ZCS2922	1.00 - 1.50	25 - 40	24	600	3,580	1,620
ZCS1177	1.25 - 1.50	30 - 40	24	600	4,920	2,230
ZCS1178	1.50 - 2.00	40 - 50	24	600	5,820	2,640
DOUBLE EYE DOUBLE WEAVE NON-METALLIC GRIP						
ZCS1182	1.25 - 1.50	30 - 40	24	600	9,860	4,470
ZCS1183	1.50 - 2.00	40 - 50	24	600	11,880	5,390
ZCS1184	2.00 - 2.50	50 - 65	24	600	15,900	7,210
ZCS1185	2.50 - 3.00	65 - 80	24	600	15,900	7,210
ZCS1186	3.00 - 4.00	80 - 100	32	800	15,900	7,210
ZCS3813	4.00 - 5.00	102 - 127	60.6	1,540	15,900	7,210

NO - NON-METALLIC (ARAMID) OFFSET EYE GRIP



Slingco Part No	Range		Lattice Length		Approx. Break Load	
	in	mm	in	mm	lb	kg
SINGLE OFFSET EYE SINGLE WEAVE NON-METALLIC GRIP						
ZCS2810	0.38 - 0.75	10 - 20	24	600	2,460	1,115
ZCS2811	0.75 - 1.25	20 - 30	24	600	3,580	1,620
ZCS2921	1.00 - 1.50	25 - 40	24	600	3,580	1,620
ZCS2812	1.25 - 1.50	30 - 40	24	600	4,920	2,230
ZCS2813	1.50 - 2.00	40 - 50	24	600	5,820	2,640
SINGLE OFFSET EYE DOUBLE WEAVE NON-METALLIC GRIP						
ZCS2814	1.25 - 1.50	30 - 40	24	600	9,860	4,470
ZCS2815	1.50 - 2.00	40 - 50	24	600	11,880	5,390
ZCS2816	2.00 - 2.50	50 - 65	24	600	15,900	7,210
ZCS2817	2.50 - 3.00	65 - 80	24	600	15,900	7,210
ZCS2818	3.00 - 4.00	80 - 100	34	860	15,900	7,210

HEAVY DUTY LARGE DIAMETER GRIPS / HOSE ARMOUR

MARINE GRIPS



These speciality grips are extremely heavy duty and suitable for large underwater pulls, plus other applications in the oil and gas industries. Galvanised steel construction for heavy duty large diameter pulls. Applications include underwater cable installation. Available in single eye, double eye lace closing and double eye. Sizes range from 4 inches to over 20 inches. Manufactured to order.

Slingco Part No	Range		Lattice length		Approx. Break Load	
	in	mm	in	mm	lb	kg
SINGLE EYE						
ZCS3525	4 - 5	102-127	94	2,360	100,000	45,370
ZCS3526	5 - 6	127-152	94	2,360	105,000	47,640
ZCS3527	6 - 8	152-203	94	2,360	112,000	50,815
ZCS3528	8 - 10	203-255	94	2,360	138,000	62,600
ZCS3529	10 - 12	255-305	94	2,360	138,000	62,600
ZCS3530	12 - 14	305-355	94	2,360	138,000+	62,600+
ZCS3531	14 - 16	355-406	118.11	2,950	138,000+	62,600+
ZCS3532	16 - 18	406-457	131.79	3,290	138,000+	62,600+
ZCS3533	18 - 20	457-508	157.48	3,940	138,000+	62,600+
ZCS3534	20 - 23	508-584	196.85	4,920	138,000+	62,600+
DOUBLE EYE						
ZCS3535	4 - 5	102-127	94	2,360	123,000	55,800
ZCS3536	5 - 6	127-152	94	2,360	123,000	55,800
ZCS3537	6 - 8	152-203	94	2,360	127,500	57,850
ZCS3538	8 - 10	203-255	94	2,360	156,500	71,000
ZCS3539	10 - 12	255-305	94	2,360	156,500	71,000
ZCS3540	12 - 14	305-355	94	2,360	156,500+	71,000
ZCS3541	14 - 16	355-406	118.11	2,950	156,000+	71,000+
ZCS3542	16 - 18	406-457	131.79	3,290	156,500+	71,000+
ZCS3543	18 - 20	457-508	157.48	3,940	156,500+	71,000+
ZCS3544	20 - 23	508-584	196.85	4,920	156,500+	71,000+
DOUBLE EYE LACE UP						
ZCS3545	4 - 5	102-127	94	2,360	123,000	55,800
ZCS3546	5 - 6	127-152	94	2,360	123,000	55,800
ZCS3547	6 - 8	152-203	94	2,360	127,500	57,850
ZCS3548	8 - 10	203-255	94	2,360	156,500	71,000
ZCS3549	10 - 12	255-305	94	2,360	156,500	71,000
ZCS3550	12 - 14	305-355	94	2,360	156,500+	71,000
ZCS3551	14 - 16	355-406	118.11	2,950	156,000+	71,000+
ZCS3552	16 - 18	406-457	131.79	3,290	156,500+	71,000+
ZCS3553	18 - 20	457-508	157.48	3,940	156,500+	71,000+
ZCS3554	20 - 23	508-584	196.85	4,920	156,500+	71,000+

HOSE ARMOUR GRIPS FOR HOSE PROTECTION



Protect hydraulic and other hoses in harsh environments. The wire mesh covering minimises damage to hose exterior from rocks, metal and other hazards common on construction and oil field sites. Hose armour kits come complete with clips for securing armour.

Slingco Part No	Range		Lattice Weave	Lattice Length	
	in	mm		in	mm
OPEN ENDED STANDARD GRIP GALVANISED					
ZCS0318HA	2.00 - 2.50	50-63	Double	42	1,065
ZCS1158HA	2.50 - 3.50	63-89	Double	48	1,220
ZCS1159HA	3.50 - 4.50	89-115	Double	54	1,370
ZCS1975HA	4.50 - 5.50	115-140	Double	54	1,370

CAN'T FIND THE SPECIFICATION YOU NEED?

Call or email for full ranges plus custom manufacture options

01706 855558

sales@slingco.com

LINE PULLING SWIVELS

LINE PULLING SWIVELS

Swivels designed for use in stringing high tension wires for electrical transmission and distribution. Swivels are important in pulling when the lines develop torsion during the installation. This torsion must be released. Use of a swivel will release torque and prevent it from reaching dangerous levels, which can cause damage to the cable or grip.

Slingco also offers a 'bull nose' style swivel designed for underground and overhead applications.

All swivels are stringently quality tested and inspected to ensure optimum performance and reliability.



STANDARD ENDS

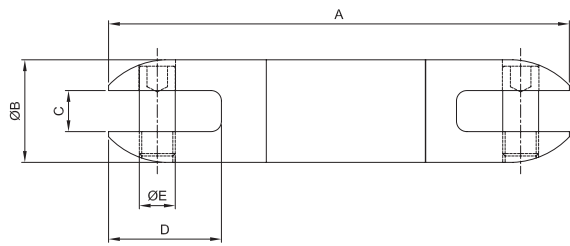

BULL NOSE

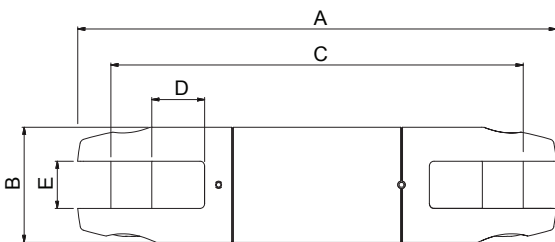

Slingco part no.	Safe working load lb (kg)		A in (mm)	Ø B in (mm)	C in (mm)	D in (mm)	Ø E in (mm)
	Underground	Overhead					
LINE PULLING SWIVEL – STANDARD ENDS							
ZSW2091	2,250 (1,015)	1,350 (610)	3 3/8 (86)	7/8 (22)	3/8 (10)	7/8 (22)	5/16 (8)
ZSW2092	3,500 (1,590)	2,100 (955)	4 (99)	1 (25)	7/16 (11)	1 1/16 (26)	3/8 (10)
ZSW2093	5,000 (2,240)	3,000 (1,345)	4 15/16 (126)	1 1/4 (32)	9/16 (14)	1 1/4 (32)	3/8 (10)
ZSW2094	7,000 (3,170)	4,200 (1,900)	5 3/16 (132)	1 3/8 (35)	9/16 (14)	1 13/32 (36)	1/2 (12.5)
ZSW2096	10,000 (4,530)	6,000 (2,700)	6 3/16 (157)	1 5/8 (41)	45/64 (18)	1 3/4 (45)	13/20 (16.5)
ZSW2097	15,000 (6,730)	9,000 (4,030)	7 5/16 (186)	2 3/32 (53)	25/32 (20)	2 1/8 (54)	23/32 (18)

LINE PULLING SWIVEL – BULL NOSE							
ZSW2649	4,000 (1,815)	2,400 (1,085)	4 3/4 (120.7)	1 1/4 (31.8)	19/32 (15.1)	1 3/16 (30.2)	3/8 (9.5)
ZSW2929	8,000 (3,630)	4,800 (2,175)	5 3/8 (136.5)	1 1/2 (38.1)	5/8 (15.9)	1 3/8 (34.9)	7/16 (11.1)
ZSW6122	10,000 (4,530)	6,000 (2,700)	7 1/32 (178.3)	1 7/8 (47.6)	6 1/16 (154)	5/8 (15.9)	3/4 (19.1)
ZSW6123	16,000 (7,142)	9,600 (4,355)	10 1/8 (257.73)	2 7/16 (62)	8 3/4 (222)	1 1/8 (28.5)	1 (25.4)
ZSW2857	30,000 (13,610)	18,000 (8,165)	11 1/8 (282.6)	2 1/2 (63.5)	1 (25.4)	2 3/4 (69.9)	7/8 (22.2)

3:1 factor of safety used, based on the ultimate load for underground use
5:1 factor of safety used, based on the ultimate load for overhead use

Swivel and Cable Grip match-up

Revolving Eye	Flexible Eye MU	Approx. breaking strength of cable grip lb (kg)	Cable grip colour code	Size range O.D. inches (mm)	Recommended swivel	Safe working load of swivel lb (kg)
LINE PULLING SWIVEL – STANDARD ENDS						
ZCS2177	ZCS1710	7,000 (3,175)	Dark green	0.25 - 0.50 (6 - 12)	ZSW2092	3,500 (1,590)
ZCS2178	ZCS1711	10,500 (4,760)	Brown	0.50 - 0.75 (12 - 19)	ZSW2093	5,000 (2,240)
ZCS2179	ZCS1712	14,100 (6,395)	Light blue	0.75 - 1.00 (19 - 25)	ZSW2093	5,000 (2,240)
ZCS2180	ZCS1713	25,000 (11,340)	Gold	1.00 - 1.25 (25 - 32)	ZSW2096	10,000 (4,530)
ZCS2181	ZCS1714	31,000 (14,065)	Black	1.25 - 1.50 (32 - 38)	ZSW2096	10,000 (4,530)
ZCS2182	ZCS1715	31,000 (14,065)	Red	1.50 - 1.75 (38 - 44)	ZSW2096	10,000 (4,530)
ZCS2183*	ZCS1716†	43,000* 49,000* (19,510) (22,230)	Dark blue	1.75 - 2.25 (44 - 57)	ZSW2097	15,000 (6,730)
LINE PULLING SWIVEL – BULL NOSE						
ZCS2177	ZCS1710	7,000 (3,175)	Dark green	0.25 - 0.50 (6 - 12)	ZSW2649	4,000 (1,810)
ZCS2178	ZCS1711	10,500 (4,760)	Brown	0.50 - 0.75 (12 - 19)	ZSW2929	5,000 (2,240)
ZCS2179	ZCS1712	14,100 (6,395)	Light blue	0.75 - 1.00 (19 - 25)	ZSW2929	5,000 (2,240)
ZCS2180	ZCS1713	25,000 (11,340)	Gold	1.00 - 1.25 (25 - 32)	ZSW6122	10000 (4,530)
ZCS2181	ZCS1714	31,000 (14,065)	Black	1.25 - 1.50 (32 - 38)	ZSW6122	10000 (4,530)
ZCS2182	ZCS1715	31,000 (14,065)	Red	1.50 - 1.75 (38 - 44)	ZSW6122	10000 (4,530)
ZCS2183*	ZCS1716†	43,000* 49,000* (19,510) (22,230)	Dark blue	1.75 - 2.25 (44 - 57)	ZSW6123	16,000 (7,257)

The above is intended as a rough guide. The recommended working load should be determined by the competent person(s) using the cable grip and/or Slingco swivel.

SAFETY NOTE: These swivels are designed for straight line pulling and will not support side loads as would be encountered traveling over a bull wheel. Swivel selection should be based on pulling line diameter, grip size, opening dimensions, pin sizes, working load, and sheave groove diameter. Swivels are not designed for general lifting.

CABLE PULLING GRIPS AND CABLE SUPPORT GRIPS

ASSESSMENT OF SUITABILITY

There are many factors that must be taken into account when assessing the suitability of a cable grip for a proposed application and trying to calculate a safe working load. These include:

- Size of cable grip in relation to size/ shape of gripped object(s)
- Stability of object(s) when gripped
- Grip surface of object(s)
- Resistive force of object(s)
- Anticipated path of movement, including possible obstructions
- Approximate breaking strength of the cable grip
- Condition of cable grip
- Suitability and compatibility of any attachments used
- Environment / operating conditions
- Persons at risk

If you have any questions regarding suitability for any particular application please call the distributor who supplied the cable grip or our in-house Technical Department.

Please note: Slingco cable grips must be double steel banded securely before being pulled.

LATTICE DIMENSIONS

Lattice dimensions shown are as fitted to a nominal diameter of cable and prior 'free length' may be slightly longer than stated.

APPROXIMATE BREAK LOAD

This is the calculated average based on actual testing done by Slingco. Approximate break loads are quoted as a guide only.

SAFE WORKING LOAD

Application load is normally calculated to be reduced by at least a factor of 5x the Approximate break load. Due to the wide variety of application parameters, the end user must apply a sensible safety factor to suit the safety requirements for the conditions of use.

The Safe Working Load (SWL) of a Slingco cable grip will depend on the Factor of Safety (FOS) applied to the Minimum Breaking Load.

FACTOR OF SAFETY (FOS)

Where the operational risk is considered to be normal, it is recommended that a FOS of 5 be applied, for a high risk operation a FOS of at least 10 should be considered. It is impossible to catalogue or guarantee a safety factor that will apply for all applications.

Approximate Break Loads stated on any certification, the recommended Factors of Safety, and any implied or stated fitness for purpose, are all only applicable when the cable grip is as new and unused.

A 20% variance in break loads must be allowed for when selecting a cable grip; a suitable swivel must be used if there is 'twist' in the cable.

Torsional stress must be dealt with when using grips for line pulls and wire splices. When twisting forces are present use a swivel that rotates under load to release torsional stress.

Cable Grip Safety Information

- Ensure that the cable grip mesh fits conductor correctly
 - Ensure that the conductor fits up to the mid-point of the protective shoulder
 - Clamp the ends of the cable grip when attaching the conductor. We recommend between 1¼" and 2¼" from the end of the cable grips
- SECURE CLAMPING MUST BE USED ON SLINGCO CABLE GRIPS**
- Never modify or attempt to repair any grip
 - Ensure proper maintenance of the cable grip. If in doubt call 888-685-9478
 - Check the condition of the cable grip, and that it is the correct size for the intended application - do not exceed the rated capacity
 - Grips that are worn, bent or otherwise damaged should not be used
 - Grips are only to be used for temporary installations
 - Pulling devices should only be attached via the pulling eye
 - Cable grips must only be fitted and used by trained competent person(s)



SLINGCO CABLE GRIPS MUST NOT BE USED TO THEIR APPROXIMATE BREAKING STRENGTH. A SENSIBLE SAFETY FACTOR MUST ALWAYS BE USED. IF IN DOUBT CONTACT THE MANUFACTURER OR THE DISTRIBUTOR THAT SUPPLIED THE GRIP!

If you have any questions regarding suitability for any particular application please call 888-685-9478

TYPICAL CONFIGURATIONS

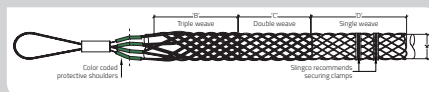
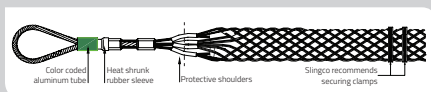



TRANSMISSION & DISTRIBUTION

Underground products are just some of Slingco's range developed for the Transmission & Distribution market. Slingco cable installation and support products are widely specified throughout the power utility industry, in such diverse applications as overhead line stringing, trench cable laying, fibre optic cable pulling and conduit riser supports.

FOR ANY ENQUIRIES CALL TODAY ON
+44 [0]1706 855558

Slingco Limited
Gateway Business Park, New Hall Hey Road, Rawtenstall, BB4 6JG, England
Tel: +44 [0]1706 855558 · Fax: +44 [0]1706 855559
sales@slingco.com



slingco.com