



2K STRAP HOIST OPERATION AND SAFETY GUIDE

SLINGCO PART NO. ZLH14321/ZLH14447



⚠ ATTENTION

READ and **UNDERSTAND** all of the instructions and safety information in this manual before operating or servicing this tool.

Failure to read and understand these warnings and safe handling instructions could result in severe personal injury or death.

KEEP THIS MANUAL WITH TOOL.

Thank you for using Slingco® products. This manual must be read and understood prior to operating this product. Special attention should be paid to the section **'Safety Information'**.

This manual should be kept available to all operating and maintenance personnel.

Additional or replacement manuals may be obtained at no charge by contacting your local Slingco office.

CONTENTS

SAFETY INFORMATION	3-5
PRODUCT DESCRIPTION	5
OPERATING INSTRUCTIONS	6-7
MAINTENANCE	7
PARTS GUIDE - ZLH14321	8-10
PARTS GUIDE - ZLH14447	11-13

SAFETY INFORMATION

⚠ ATTENTION

DO NOT perform any service or maintenance on this tool other than described in this manual.

Read and follow the operator's manual before using this tool.

This manual should be kept available to all operating and maintenance personnel.

⚠ WARNING SAFETY SHOES REQUIRED



- Safety shoes required when using this product.

⚠ WARNING PINCH POINT HAZARD



- Keep hands away from hoist mechanism, or serious injury may occur.

⚠ WARNING HARD HAT REQUIRED



- **DO NOT** operate without proper head protection.

⚠ WARNING SAFETY GOGGLES REQUIRED



- **DO NOT** operate without eye protection, or serious injury may occur.

⚠ WARNING GLOVES REQUIRED



- **DO NOT** operate without proper hand protection.

⚠ WARNING SUSPENDED LOAD



- Heavy suspended objects can fall, causing property damage, severe injury, or even death.
- **DO NOT** stand under Strap Hoist.
- **DO NOT** lift or pull more than rated load.

⚠ WARNING ELECTRICAL SHOCK HAZARD



- This tool is **NOT** insulated.
- Failure to observe this warning could result in severe injury or death.

SAFETY INFORMATION (CONT.)

WORK AREA SAFETY

1. Keep the area around the equipment clean and free of obstruction.
2. Bystanders should stay clear of the work area to ensure safety.

PERSONAL SAFETY

1. Stay alert while using the equipment to prevent serious injury. Do not use under the influence of drugs, alcohol or medications.
2. Do not wear loose hair or clothes that may get caught while the equipment is in operation.
3. Work safely. Ensure firm footing, be properly secured, and do not over-extend yourself while operating equipment.

TOOL USE AND CARE

1. **DO NOT** use this tool if there are any abnormalities or damage to any of its components.
2. Inspect the tool before and after every use. Do not use this tool if it is damaged in any way. Ensure that all pins are secure.
3. When having the tool repaired, always use factory Slingco replacement parts. Tools must be serviced and/or repaired by Slingco or a factory authorized service center.

SAFETY INFORMATION (CONT.)

WARNINGS

Failure to observe any of the following warnings could result in severe injury or death.

- Do not use this hoist with damaged or worn strap.
- Do not operate the hoist with any extension or cheater bar. Only use Slingco provided handle for operation of hoist.
- Do not use the hoist to lift or support people.
- Protect the hoist strap from sharp objects, chemicals, excessive UV or anything else that could damage the integrity of the strap.
- Hoist is only to be operated in a straight line pull or lift hook-to-hook.
- Do not apply load to the tip of the hook or hook latch.
- Do not wrap web strap around object being pulled or lifted. Only use hooks for lifting or pulling.
- Do not attempt to free wheel hoist while under load.
- Do not let the strap overlap the teeth or sides of the drum. Web strap must be locked in the center of drum.
- Do not leave hoist unattended while loaded.
- Ensure all pawls are in place and all slack has been removed from strap prior to operation.
- Do not release the handle until operating stroke is completed and the handle is at rest.
- Do not allow more than one operator to pull on the handle at the same time.

DESCRIPTION

Slingco Part No.	Type	SINGLE LINE						DOUBLE LINE						Tool weight (lb) (kg)	
		Capacity (lb) (kg)		Lift (ft) (m)		Headroom (in) (mm)		Capacity (lb) (kg)		Lift (ft) (m)		Headroom (in) (mm)			
ZLH14321	Standard	1,000	453	9.5	2.9	15.5	394	2,000	907	4.6	1.4	18.5	470	8.46	3.84
ZLH14447	Hot stick operated	1,000	453	9.5	2.9	15.5	394	2,000	907	4.6	1.4	18.5	470	9.04	4.10

OPERATING INSTRUCTIONS

LIFTING OR PULLING

Place the handle in the U-frame and engage the handle locking screw prior to operation. Place control lever perpendicular to the frame as pictured, engaging the loading pawl against the teeth of drum. Work the handle as required to get desired operation.

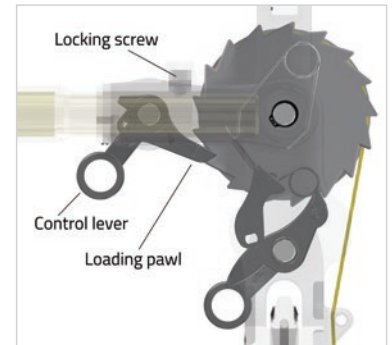
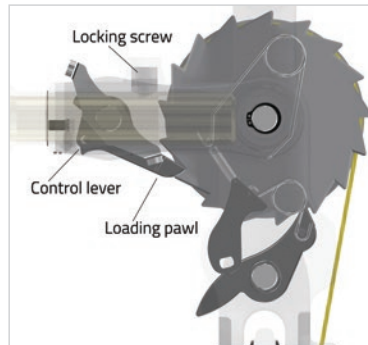

LOWERING

Place control lever perpendicular to the frame as pictured. Operate the handle to its furthest down position until load is removed from holding pawl. Release downward pressure on handle slowly. The load will be lowered or released one notch on the drum at a time. Continue to lower or release load by repeating the operation. Lowering or releasing heavy loads is easier if a quick downward handle motion is used.

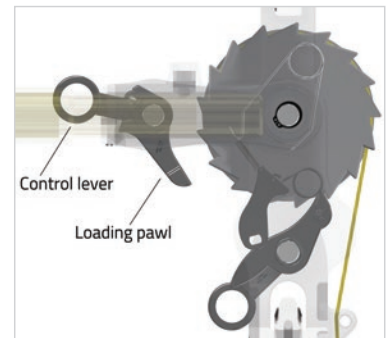
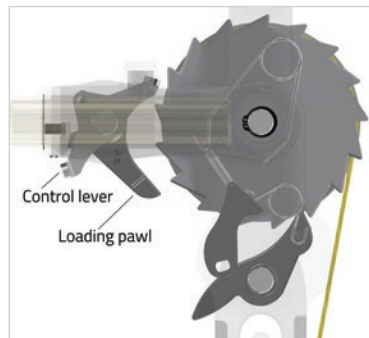

FREEWHEELING

Place control lever perpendicular to the frame as pictured. Push spring loaded holding pawl into position. The strap can now be pulled from the drum to gain the length needed to reach the attachment point. Likewise, with the control lever in perpendicular position, excess slack may be removed and rewound onto the drum using the winding wheel.

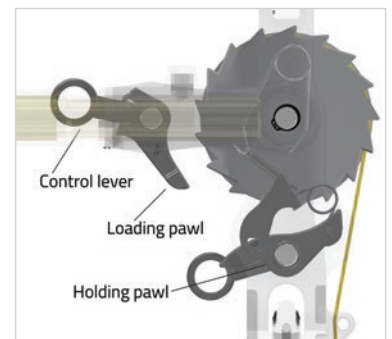
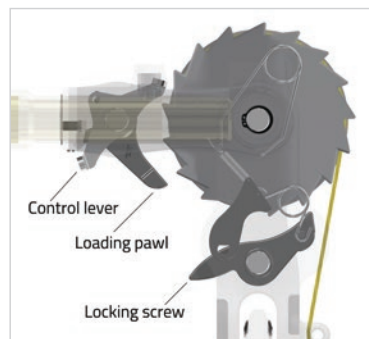

OPERATING INSTRUCTIONS (CONT.)

As already stated in *Safety Information*, do not use this tool if there are any abnormalities, or damage to any of the components. This includes any damage to hooks, frame, handle, pawls or strap. During inspection, operator should be looking for any signs of distortion, cracks or breaks to any metal parts. Strap should be inspected for cuts and frays, broken stitches or any UV or chemical breakdown or exposure. If anything listed is found, immediately tag and remove the tool from use. When repairing hoist use only factory Slingco parts. All warning and capacity labels should be on the hoist.

Hoist should be inspected prior to and after each use.

MAINTENANCE

STORAGE

While hoist is not in use, it is best to place the hoist in truck tool bins. Hang the hoist by the upper hook with the strap wound up to minimize exposure to any elements. If the strap becomes wet during work, it is best to let the strap dry prior to winding up.

CLEANING

Cleaning your hoist is not typically necessary. But when the need arises, clean metal parts and web strap with mild soap or detergent and water. Be sure to allow strap to dry before winding the strap back up and beginning use again. After hoist has been cleaned, it must be lubricated.

LUBRICATION

When lubricating any of the following, only apply small amounts, and take extra precautions not to allow any lubricants to contact strap.

While performing an inspection before and after use of the hoist, apply light grease (synthetic or lithium-based) to the contact points between loading pawl and pin.

The following parts should be lubricated with a motor oil (Aerokroil or equivalent is advised):

- Hook shank
- Rotating points of shafts, with the exception of the drum shaft

INSPECTION REQUIREMENTS

Inspections must be conducted at a minimum as specified in the inspection chart on page 9. However, federal, local, or company inspection policies supersede this schedule.

Any deficiencies identified during an inspection must be carefully evaluated to determine if they pose a safety risk. A designated person shall assess the severity of the irregularity and decide whether further inspection, corrective action, or disassembly is necessary.

Operators or other designated personnel should perform visual checks for any damage during regular service. Formal recorded inspections shall be conducted by a designated person.

As a web strap nears the end of its useful life, the frequency of detailed inspections should be increased to ensure continued safety and reliability.

If a hoist has been out of service for one year or more, it must undergo a periodic inspection before being returned to operation.

INSPECTION REQUIREMENTS (CONT.)

Description	Weekly usage	Daily usage	Severe service (daily usage in severe weather)
Regular Inspection (Visual)	Before each use	Before each use	Before each use
Web strap for melting, charring, burns, splatter, broken stitching, cuts or tears, abrasive wear, and knots	✓	✓	✓
Frequent Inspection (Visual)	Monthly	Weekly	Daily to weekly
All functional mechanisms for proper operation not limited to raising, lowering, and freewheeling	✓	✓	✓
Hooks and latches for deformation, chemical damage, cracks, and wear	✓	✓	✓
Hook latch operation	✓	✓	✓
Levers for bends, cracks, or other damage	✓	✓	✓
Hoist support for damage	✓	✓	✓
Periodic Inspection (Record)	Annually	Semi-annually	Quarterly
Evidence of loose pins, nuts, or rivets	✓ ✓	✓ ✓ ✓	✓ ✓ ✓
Evidence of worn, corroded, cracked or distorted parts not limited to load blocks, housing, levers, clevises, yokes, gears, spool, locking, and clamping devices	✓ ✓	✓ ✓ ✓	✓ ✓ ✓
Evidence of damage to hook retaining nuts and pins	✓ ✓	✓ ✓ ✓	✓ ✓ ✓
Evidence of worn pawls, cams, or ratchet	✓ ✓	✓ ✓ ✓	✓ ✓ ✓
Evidence of corroded, stretched, or broken springs	✓ ✓	✓ ✓ ✓	✓ ✓ ✓
Warning labels are properly attached and legible	✓ ✓	✓ ✓ ✓	✓ ✓ ✓
Web strap end connections, terminations, and sections of rapid deterioration due to high contact or that are typically visually hidden	✓ ✓	✓ ✓ ✓	✓ ✓ ✓

✓ Inspection by operator or other designated personnel.

✓ ✓ Inspection by designated person of conditions.

✓ ✓ ✓ Inspection by designated person of conditions unless disassembly is required for detailed inspection.

PARTS LIST FOR ZLH14321 (2K HOIST)

Item	Slingco Part Number	Description	Qty	Item	Slingco Part Number	Description	Qty
1	ZLH14403	Drum Casting	Pack of 1	17	ZLH14411	Idler Roller Assembly	Pack of 1
2	ZLH14404	Web Strap	Pack of 1	18	ZLH14412	Yoke Casting	Pack of 1
3	ZLH13614	Holding Pawl with Pin	Pack of 10	19	ZLH14413	Yoke Roller Shaft	Pack of 1
4	ZLH14405	Holding Pawl Shaft	Pack of 1	20	ZLH14414	Yoke Roller	Pack of 1
5	ZLH13608	Nylon Wheel	Pack of 1	21	ZLH14966	Latch Spares Kit	Pack of 10
6	ZLH14406	Drum Shaft	Pack of 1	22	ZLH13617	Steel Retaining Ring	Pack of 20
7	ZLH13745	Torsion Spring	Pack of 10	23	ZLH14415	Handle Assembly	Pack of 1
8	ZLH13620	∅0.125" x 1.25" Roll Pin	Pack of 20	24	ZLH13595	Control Casting Assembly	Pack of 10
9	ZLH13621	∅0.125" x 1.5" Roll Pin	Pack of 20	25	ZLH14416	Swivel Shackle Assembly	Pack of 1
10	ZLH14407	Main Frame Assembly	Pack of 1	26	ZLH14417	U-Frame Assembly	Pack of 1
11	ZLH14408	Hook	Pack of 1	27	ZLH13563	Loading Pawl Casting	Pack of 10
12	N/A		Pack of 1	28	ZLH14418	Loading Pawl Shaft	Pack of 1
13	ZLH14409	Main Frame Roller Guide	Pack of 1	29	ZLH13565	Reversing Spring	Pack of 10
14	ZLH14410	∅0.25" x 1.625" Roll Pin	Pack of 20	30	ZLH13566	Control Lever	Pack of 10
15	ZLH13622	9/16"-12 Hex Slotted Nut	Pack of 10	31	ZLH14419	U-Frame Casting	Pack of 1
16	ZLH13619	∅0.125" x 0.875" Roll Pin	Pack of 20	32	ZLH13613	Handle Locking Screw	Pack of 10

Note: Parts in bold can be purchased as full assemblies. Sub level parts which are used in these assemblies can be found underneath.

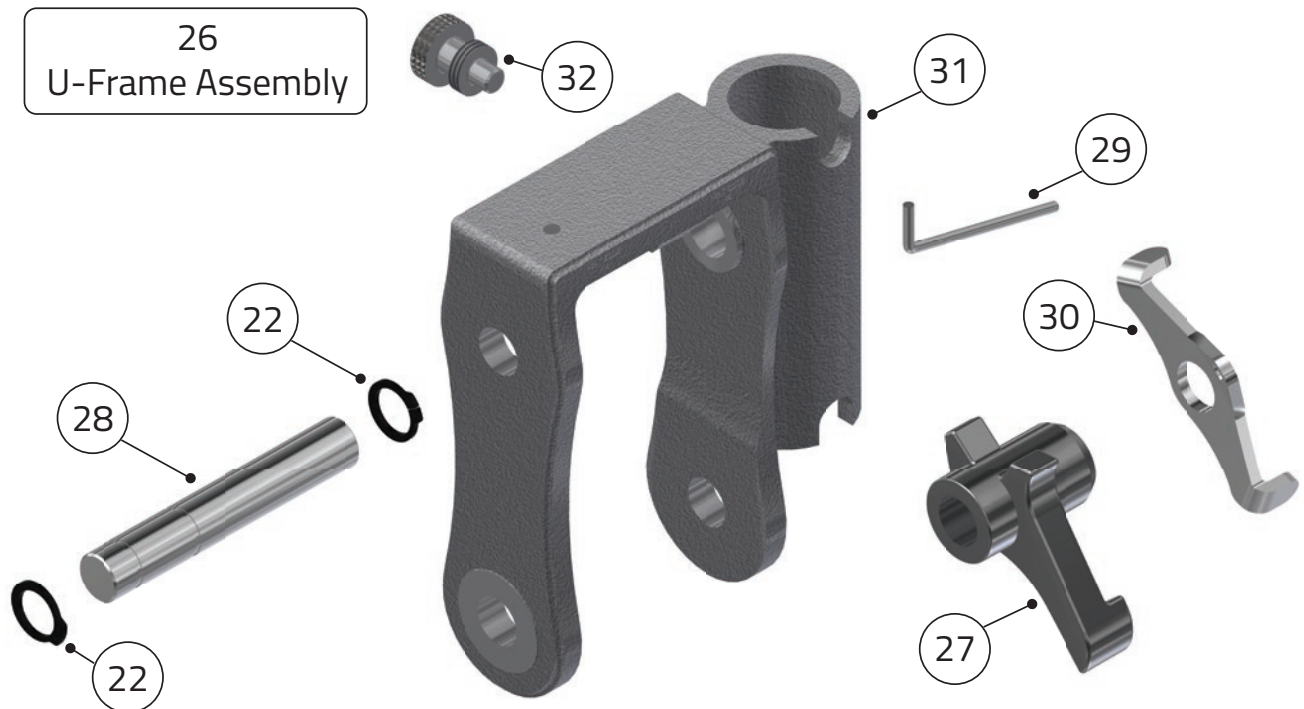

PARTS LIST FOR ZLH14321 (2K HOIST) (CONT.)



PARTS LIST FOR ZLH14447 (2K HOT STICK OPERATED HOIST)

Item	Slingco Part Number	Description	Qty
1	ZLH14403	Drum Casting	Pack of 1
2	ZLH14404	Web Strap	Pack of 1
3	ZLH13926	Holding Pawl with Pin	Pack of 10
4	ZLH14729	Holding Pawl Shaft	Pack of 1
5	ZLH13608	Nylon Wheel	Pack of 1
6	ZLH14406	Drum Shaft	Pack of 1
7	ZLH13745	Torsion Spring	Pack of 10
8	ZLH13620	Ø0.125" x 1.25" Roll Pin	Pack of 20
9	ZLH13621	Ø0.125" x 1.5" Roll Pin	Pack of 20
10	ZLH14730	Main Frame Assembly	Pack of 1
11	ZLH14731	Hook with Ring	Pack of 1
12		N/A	Pack of 1
13	ZLH14409	Main Frame Roller Guide	Pack of 1
14	ZLH14410	Ø0.25" x 1.625" Roll Pin	Pack of 20
15	ZLH13622	9/16"-12 Hex Slotted Nut	Pack of 10
16	ZLH13619	Ø0.125" x 0.875" Roll Pin	Pack of 20

Item	Slingco Part Number	Description	Qty
17	ZLH14732	Idler Roller Assembly	Pack of 1
18	ZLH14412	Yoke Casting	Pack of 1
19	ZLH14413	Yoke Roller Shaft	Pack of 1
20	ZLH14414	Yoke Roller	Pack of 1
21	ZLH14966	Latch Spares Kit	Pack of 10
22	ZLH13617	Steel Retaining Ring	Pack of 20
23	ZLH14733	Handle Assembly	Pack of 1
24	ZLH13595	Control Casting Assembly	Pack of 10
25	ZLH14734	Swivel Shackle Assembly	Pack of 1
26	ZLH14735	U-Frame Assembly	Pack of 1
27	ZLH13924	Loading Pawl Casting	Pack of 10
28	ZLH14736	Loading Pawl Shaft	Pack of 1
29	ZLH13565	Reversing Spring	Pack of 10
30	ZLH13923	Control Lever	Pack of 10
31	ZLH14419	U-Frame Casting	Pack of 1
32	ZLH13613	Handle Locking Screw	Pack of 10
33	ZLH13918	Hot Stick Lever	Pack of 1

Note: Parts in bold can be purchased as full assemblies. Sub level parts which are used in these assemblies can be found underneath.

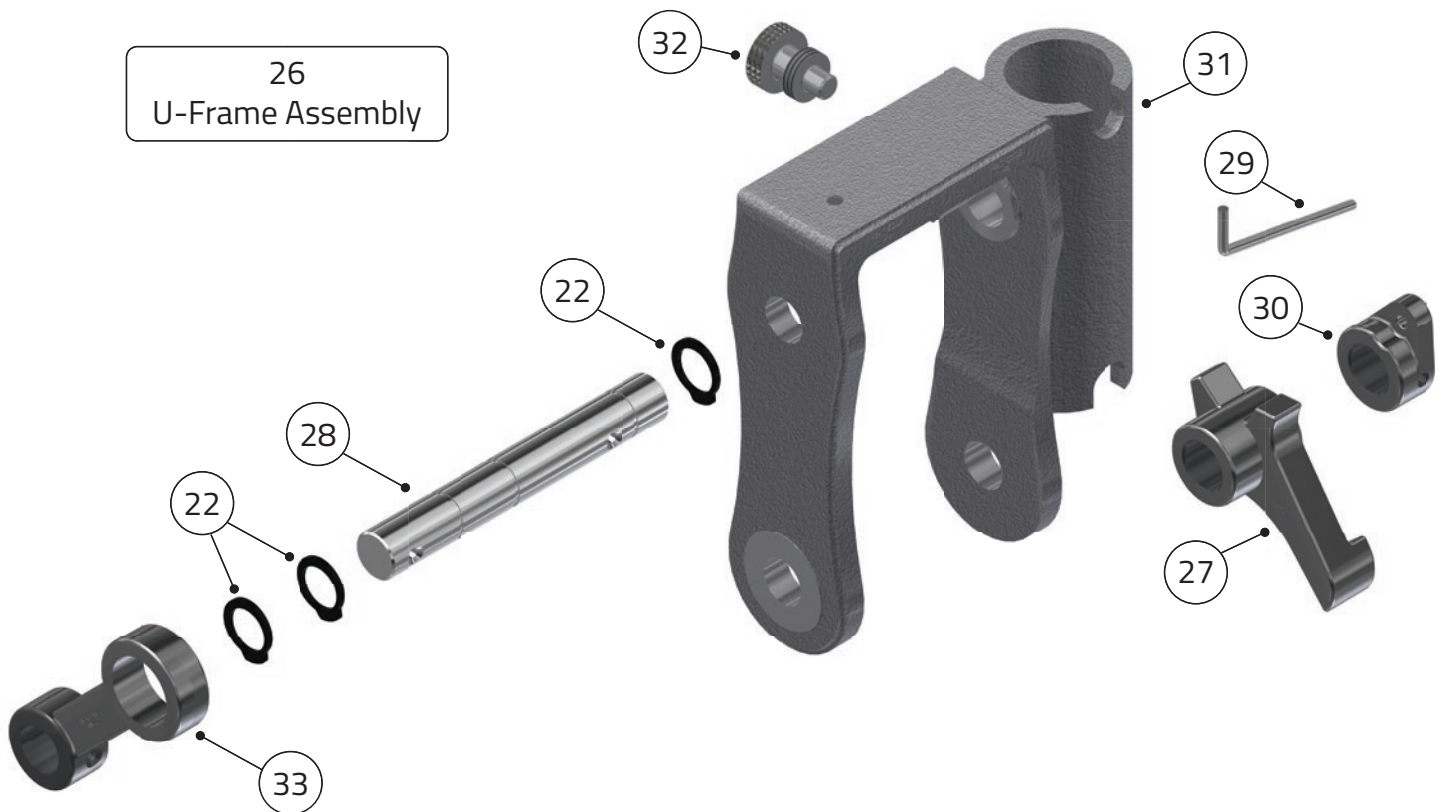

PARTS LIST FOR ZLH14447 (2K HOT STICK OPERATED HOIST) (CONT.)

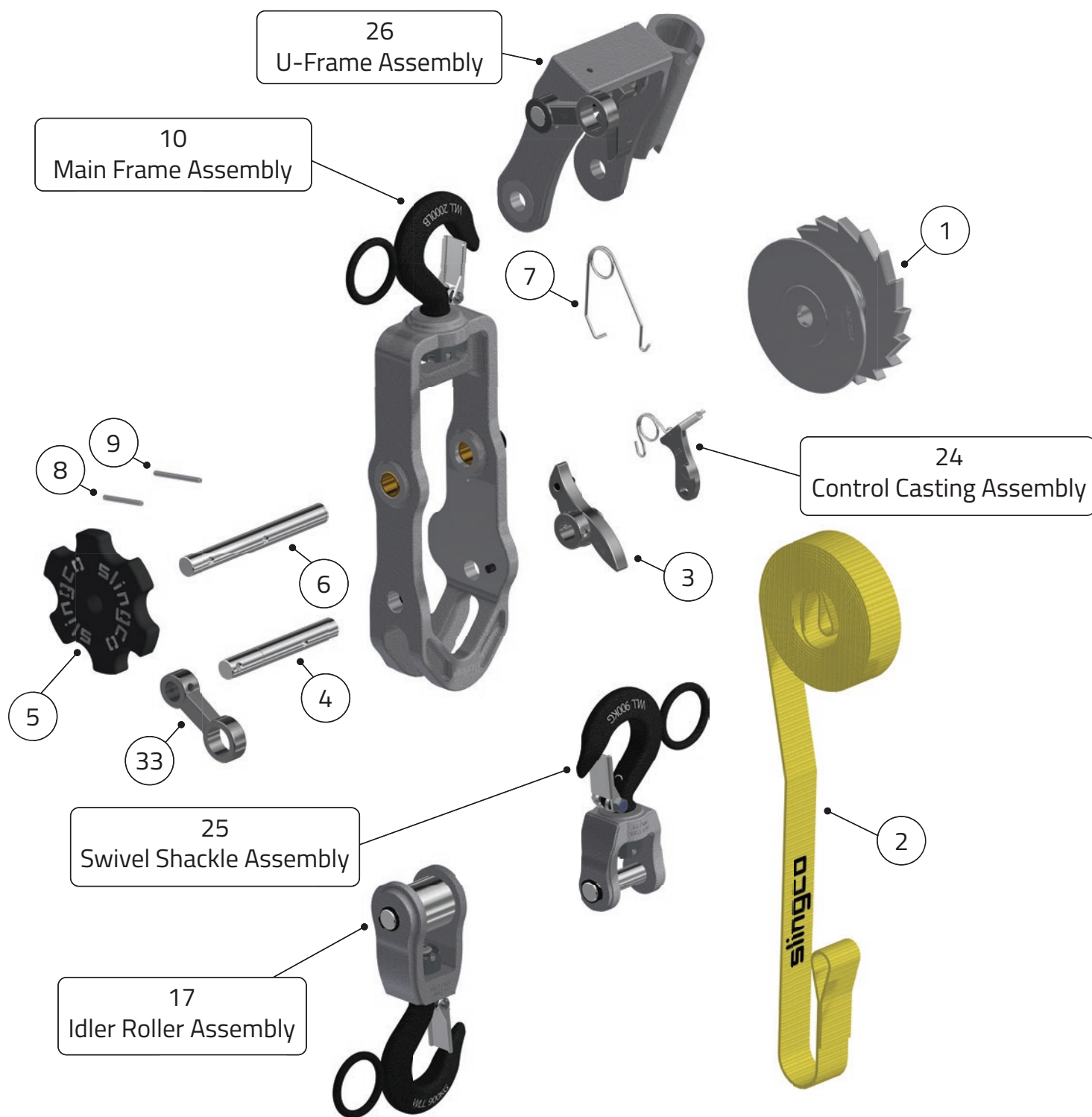

PARTS LIST FOR ZLH14447 (2K HOT STICK OPERATED HOIST) (CONT.)

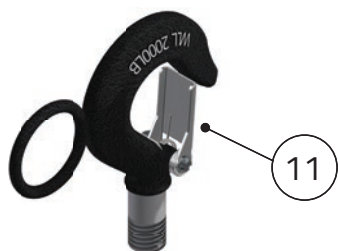

23
Handle Assembly



10
Main Frame Assembly

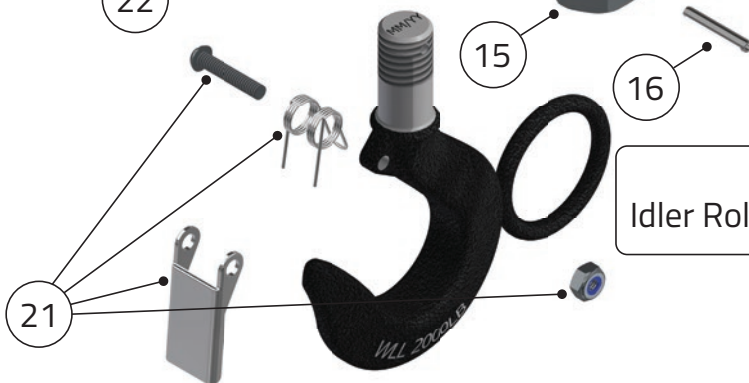
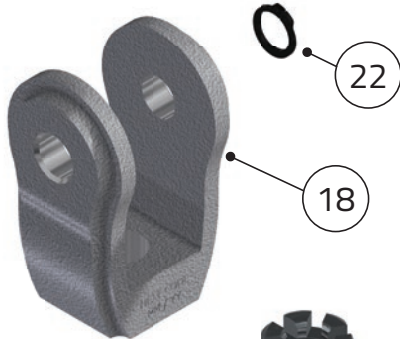
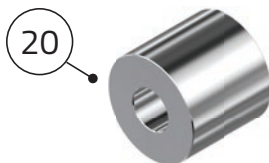
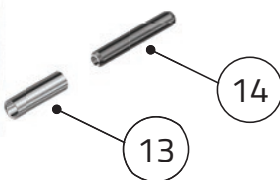

17
Idler Roller Assembly



ATTENTION

READ and **UNDERSTAND** all of the instructions and safety information in this manual before operating or servicing this tool.

Failure to read and understand these warnings and safe handling instructions could result in severe personal injury or death.

KEEP THIS MANUAL WITH TOOL.

WARNING

Cancer and Reproductive Harm www.P65Warnings.ca.gov



Slingco America, Inc.
3100 Jonquil Drive SE,
Smyrna, Georgia, 30080, USA
TOLL FREE: 888 685 9478
sales@slingcoamerica.com

888-685-9478

slingco.com

Slingco Limited
Gateway Business Park, New Hall Hey Road,
Rawtenstall, BB4 6JG, England
Tel: +44 [0]1706 855558
sales@slingco.com

+44 [0]1706 855558

Slingco Australia Pty. Ltd.
L9, 1 York Street, Sydney,
NSW 2000, Australia
Sales: +61 3 8840 6556
sales@slingcoaustralia.com.au

+61 3 8840 6556